



시스코 SDN 전략

시스코 시스템즈 코리아

김형수 부장

hyungsok@cisco.com

목 차

1

Cisco SDN 전략

2

데이터센터 SDN 전략

3

엔터프라이즈 네트워크 SDN 전략

4

통신사업자 SDN 전략

5

Summary

Cisco SDN 전략

Innovation, Disruption, Open

Application Centric & Policy - Abstraction

대규모 환경 & 효율적인 자원 활용

자동화 및 오케스트레이션

데이터센터 SDN 전략

Application Centric

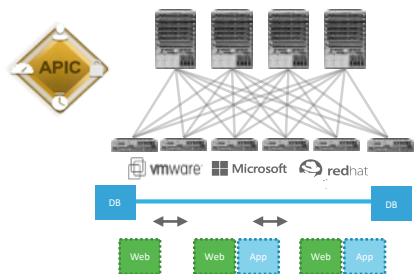

정책기반 데이터센터

SDDC/가상화/오버레이

L4-L7 연동/에코파트너

Programmable Fabric

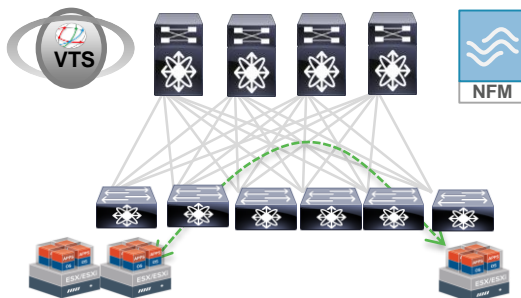

오버레이기반 확장

멀티테넌트/가상화/자동화

멀티벤더/단계별확장

Programmable Network

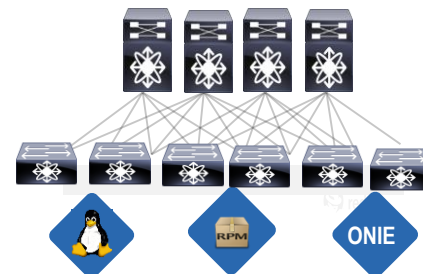

API 기반 관리/확장

DevOps/자동화/Open

고객 관리/운영 시스템

데이터센터 전략



데이터센터 변화

전통적인 데이터센터

- 어플리케이션
- HA 보다 Distributed
- NoSQL/Bigdata/Hadoop
- VM/Container
- 효율 vs. 스피드

정책기반의 하이퍼스케일

자동화/정책기반

현재 시점

클라우드 데이터센터

하이브리드
클라우드

IT as a Service

IaaS | PaaS | SaaS | XaaS

유연한 IT 모델

통합시기

가상화 시기

효율성

단순화 | 민첩성

모든 비즈니스 디지털화

2000

2010

2015

The Next 5+ Years

Application Centric Infra를 위한 시스코 기술전략

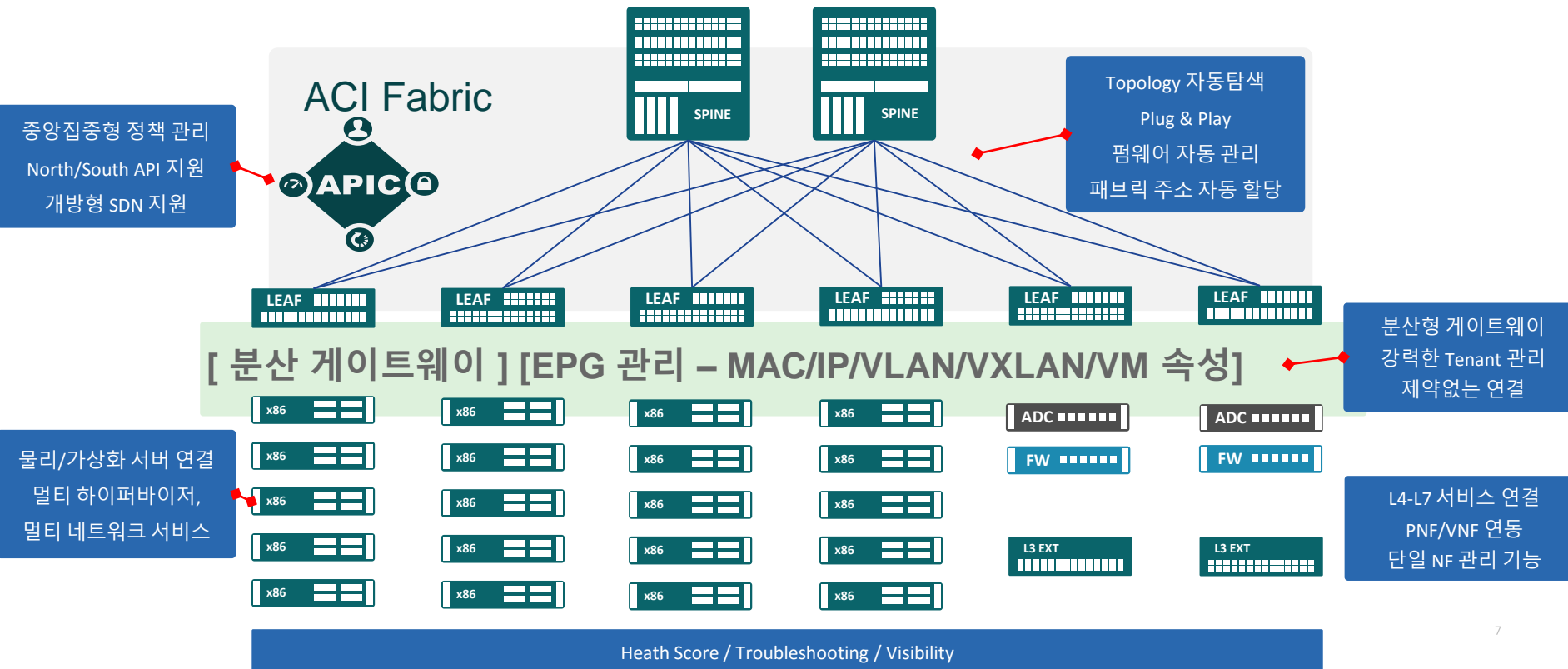

정책 기반의 SDN 솔루션

정책기반 논리적인 Application Network Profile



ACI 네트워크 프로파일 기반의 서비스 MAP 구성(ANP)

정책 구성 및 배포

Data Flow에
개입하지 않음.

Declarative 모델

물리적 ACI Fabric

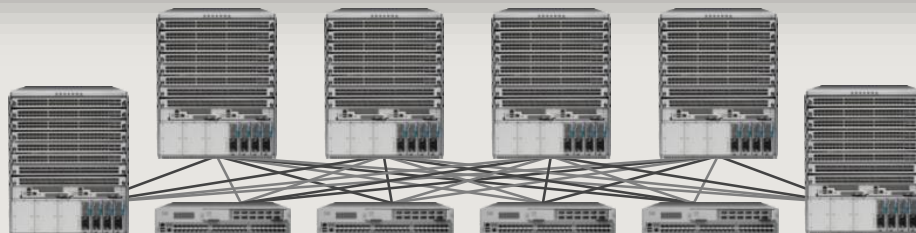

LLDP 기반
자동 Discovery

VLAN, VXLAN, MAC, IP, VM속성
서비스 분류

네트워크 자원
자동 인식 및 분류

분산형 제어부 구조

ACI VMM 아키텍처 - Openstack Neutron ML2

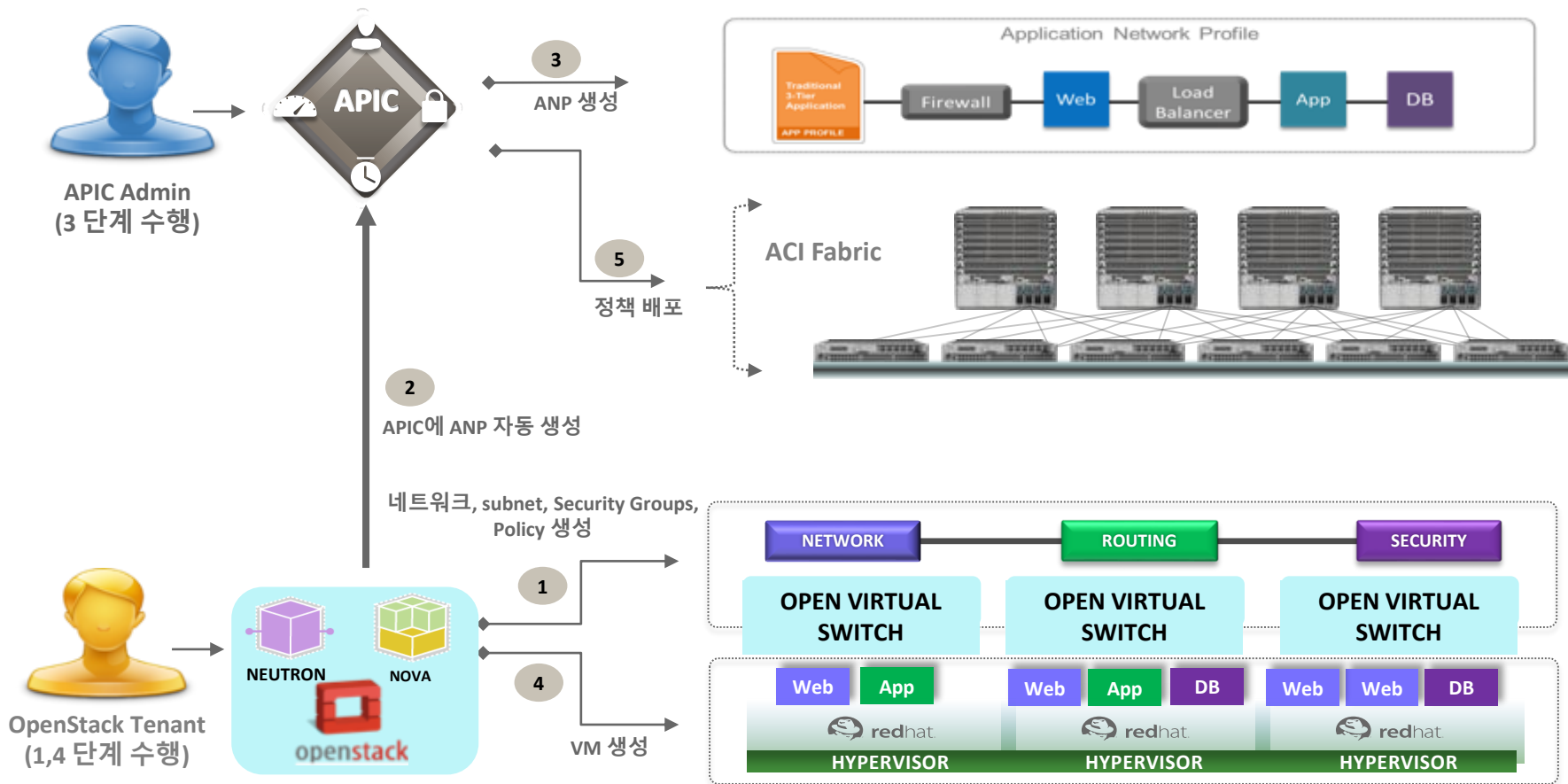

ACI VMM 아키텍처 - Openstack GBP Plugin

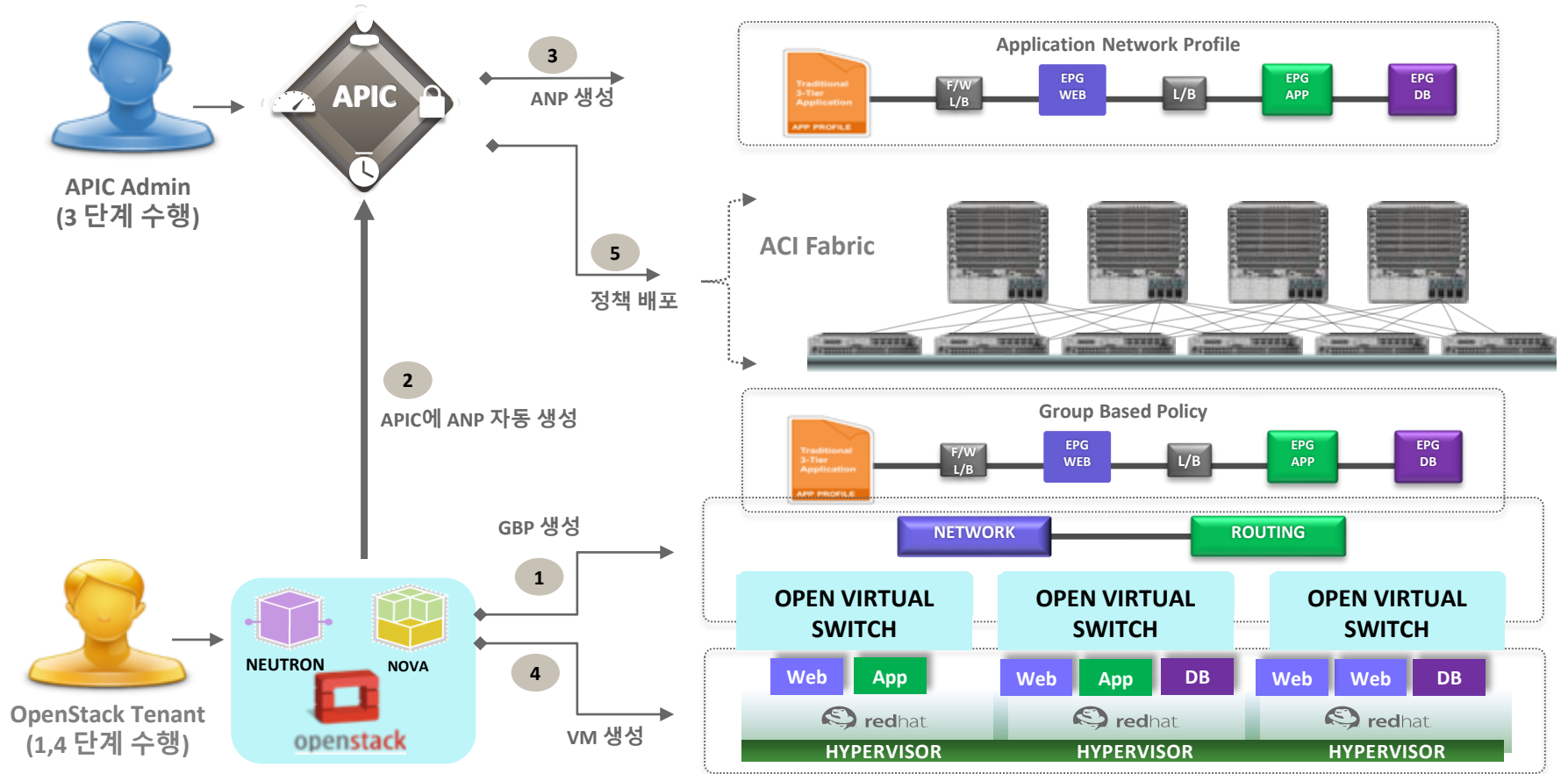

Programmable Fabric을 위한 시스코 기술전략

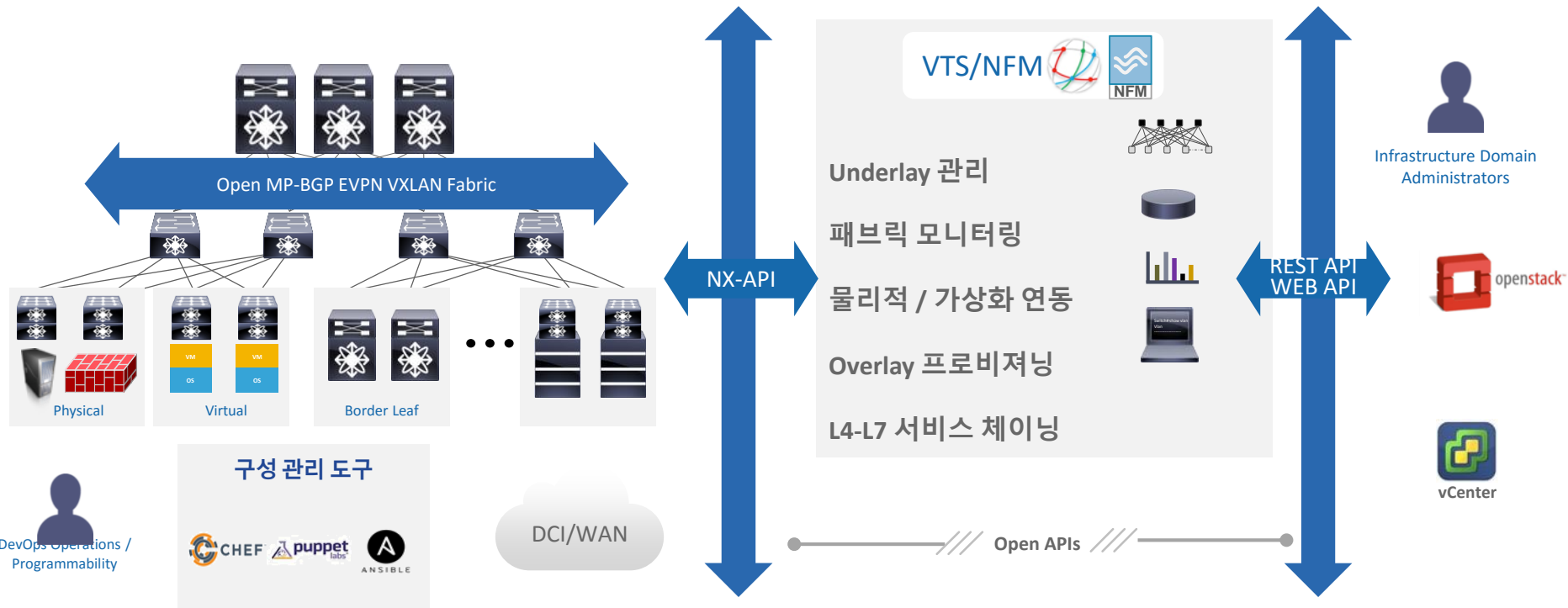

네트워크 오버레이 필요성

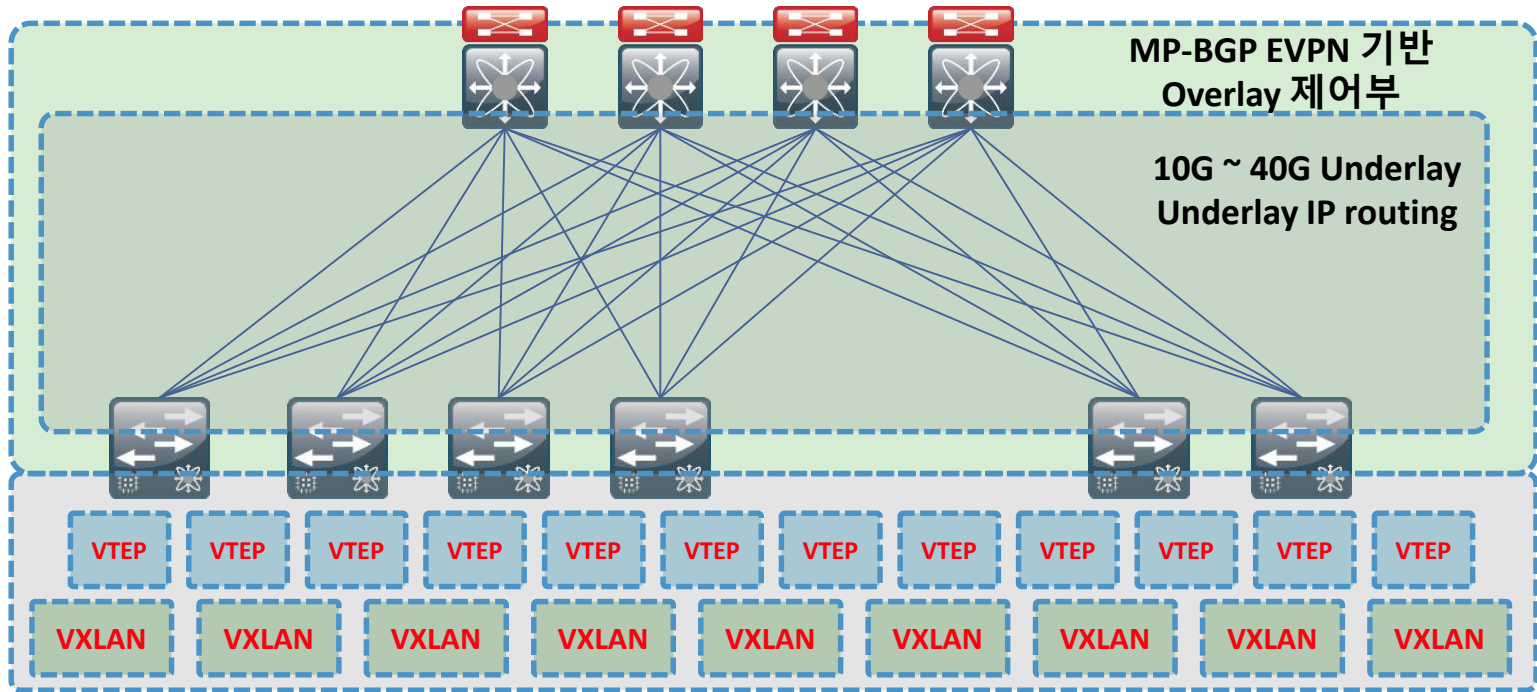

효율적인 ARP 제어

이동성

EAST-WEST 트래픽

확장성 / 안정성

VTS - 오버레이 프로비저닝 & 관리

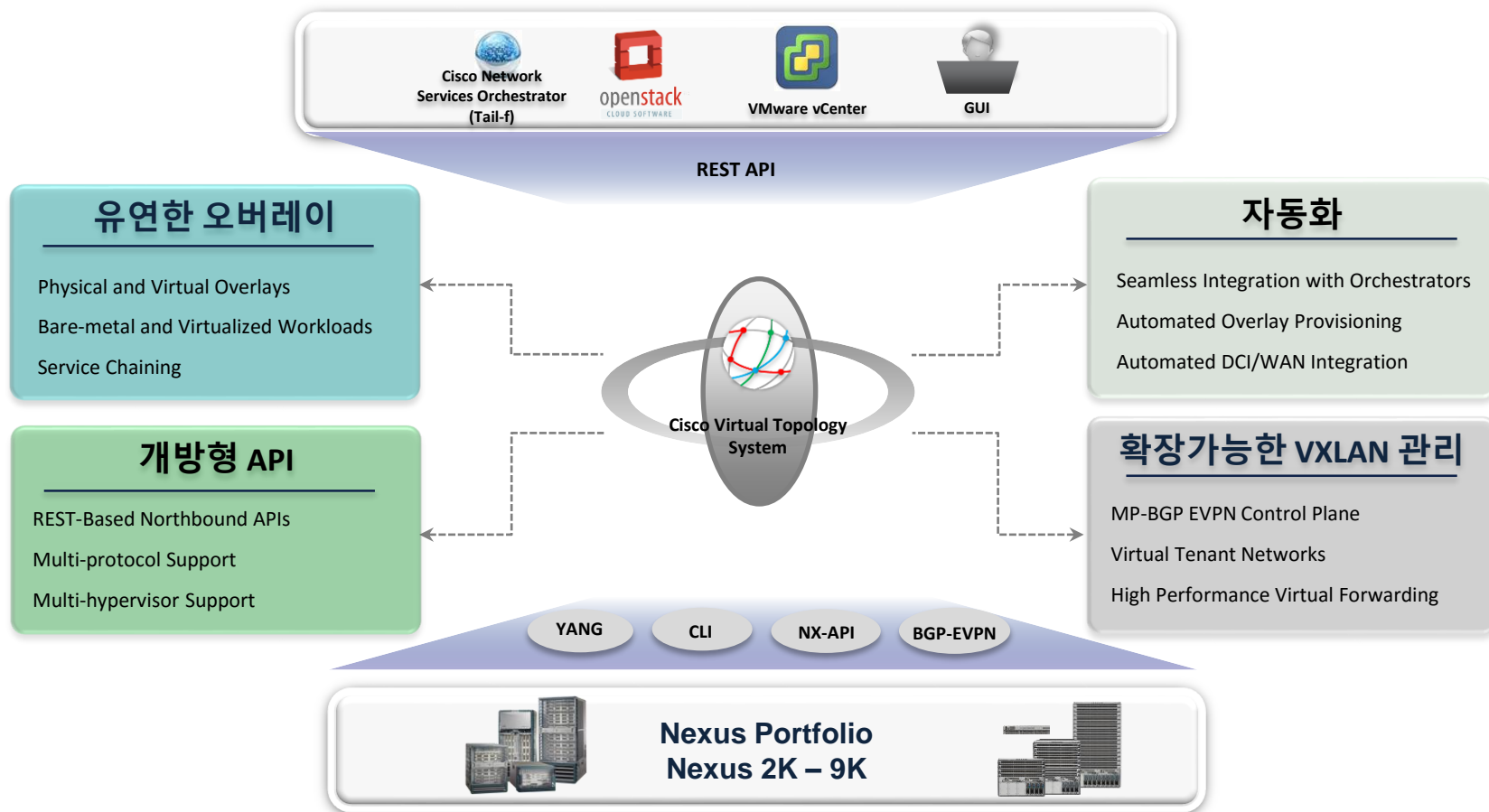

Programmable Network을 위한 시스코 기술 전략

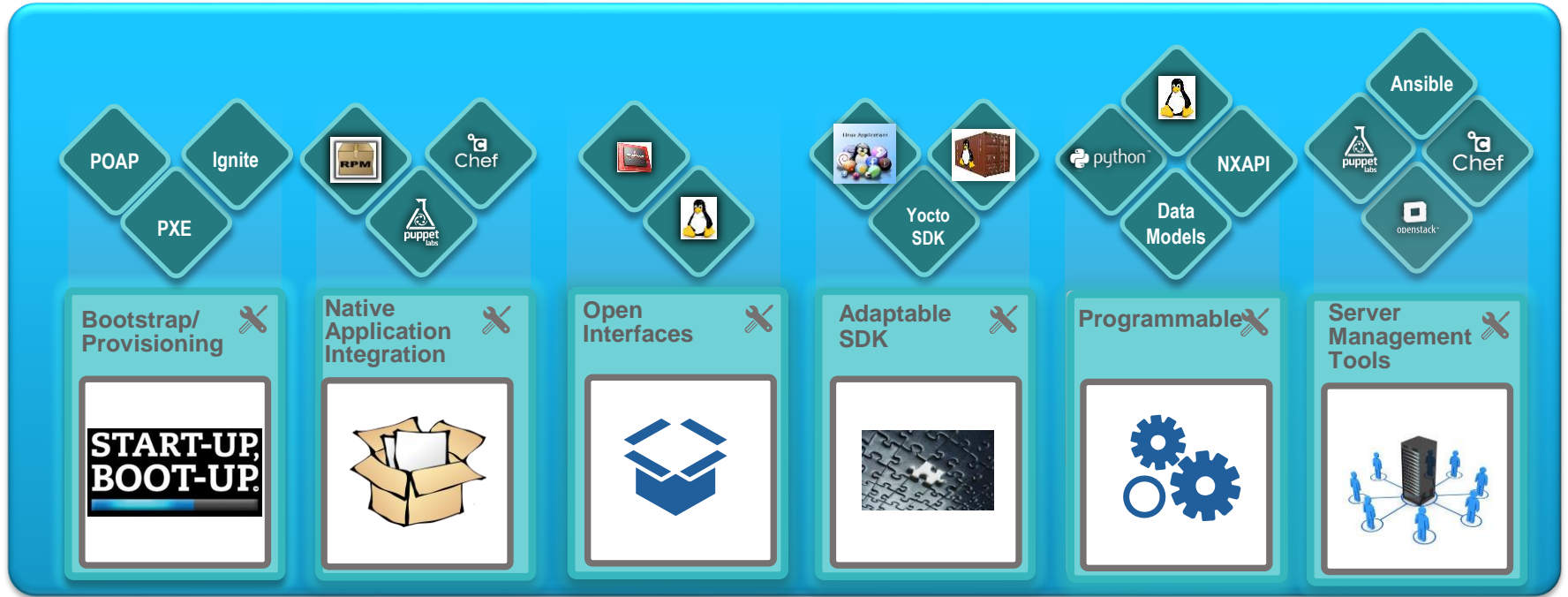

Auto Deployment
Options

Extensibility

Open

Application
Integration

Programmability
Tool Choice

DevOps
Enabling

Open Interfaces: NX-OS Kernel Stack Interfaces

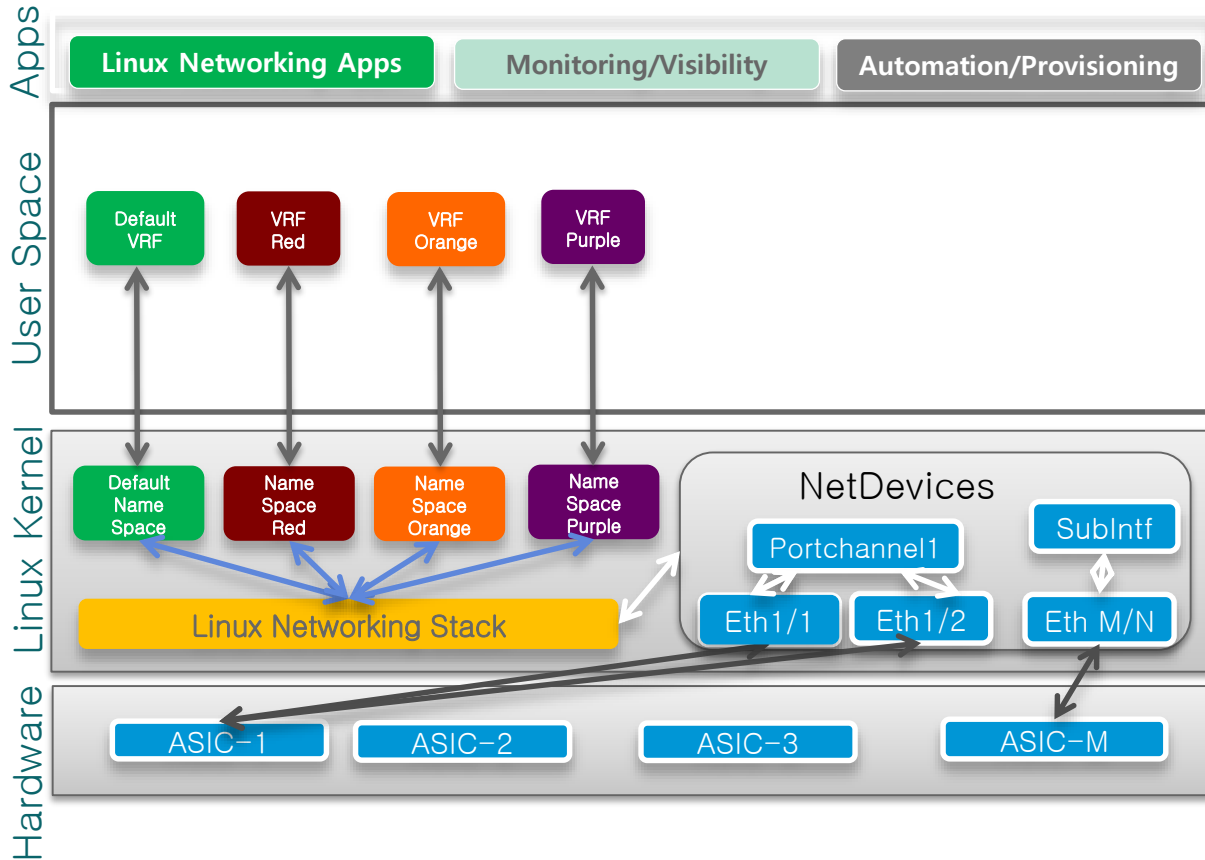

- NX-OS의 VRF와 Linux name space가 매핑
- VRF 내 포워딩 정보는 Linux Name space에 접근 가능
- Linux 명령어 `setns`, `ip-netns` 로 VRF 변경 및 route 추가 가능

Model Driven Architecture - Open NXOS

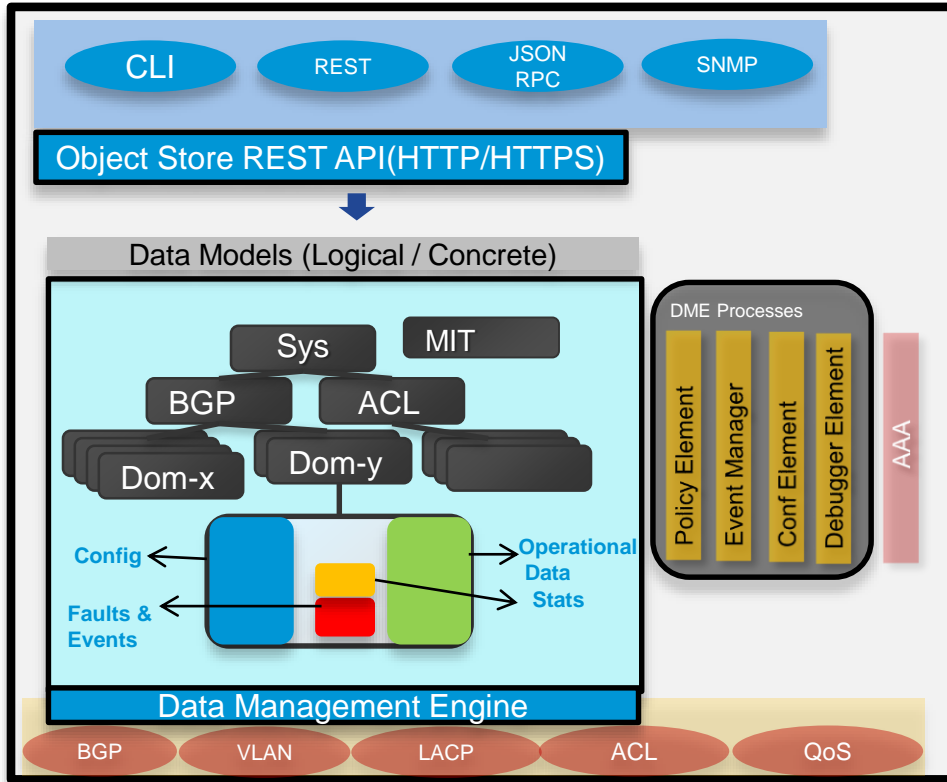

- 모델 기반 자동화
- REST API를 이용한 Nexus Object Store 제어
- 모델에 대한 Create/Retrieval/Update/Delete 동작
- 모델 기반 자동화 장점
 - 소프트웨어 생산성
 - 소프트웨어 유지보수성
 - 소프트웨어 품질 및 코드 재사용성
- 비동기 방식 지원
- Websocket을 이용한 Push 지원

데이터센터 SDN 선택

Application Centric Infrastructure

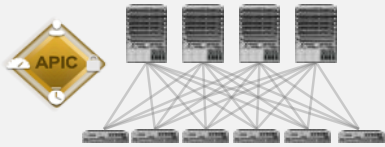

Turnkey integrated solution with security, centralized management, compliance and scale

Automated application centric-policy model with embedded security

Broad and deep ecosystem

Programmable Fabric

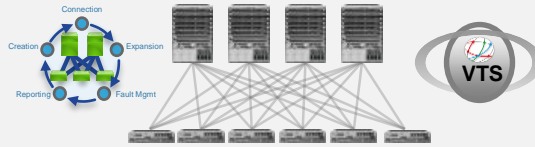

Integrated stack
Or
A-la-carte Automation

Streamlined Workflow Management

Programmable Network



Modern NX-OS with enhanced NX-APIs

DevOps toolset used for Network Management
(Puppet, Chef, Ansible etc.)

Custom Script based Operations and Workflows

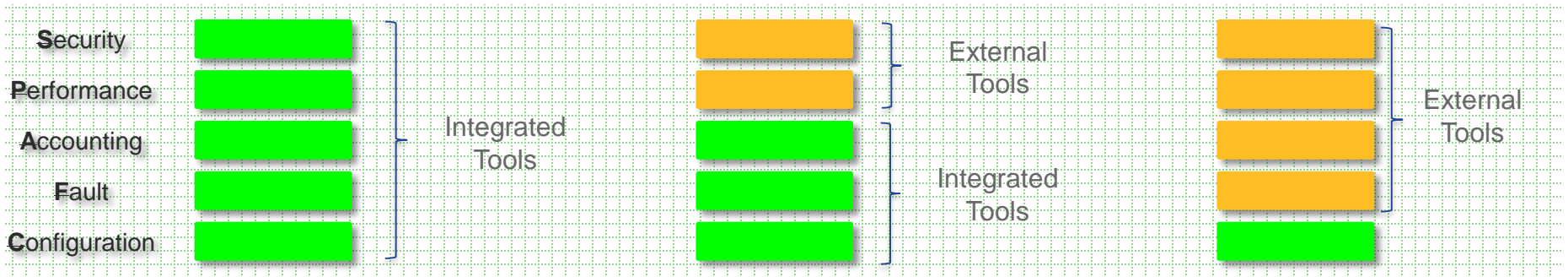



엔터프라이즈 네트워크 전략

엔터프라이즈 네트워크 SDN 전략 - DNA

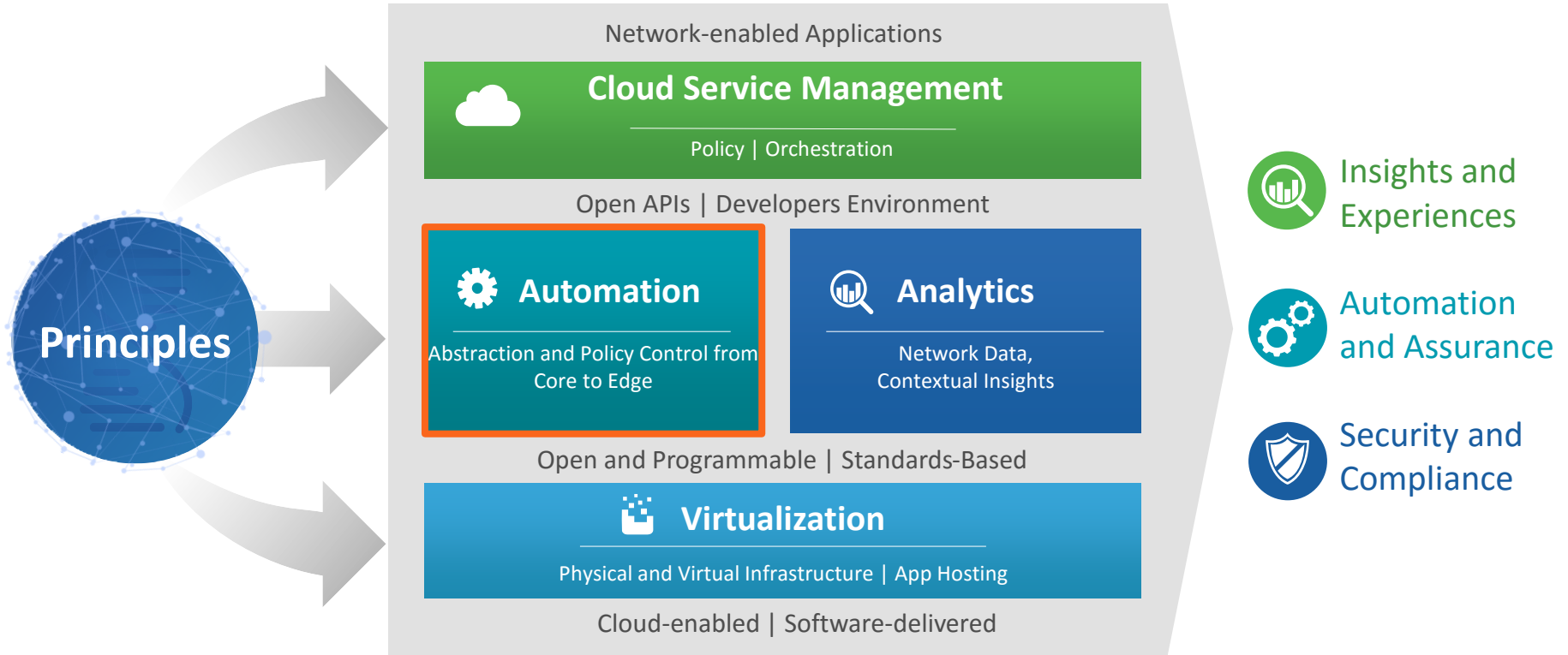

정책기반 서비스 플랫폼



네트워크에 대한
기술적 차이를 줄이고
복잡한 과정을 간소화

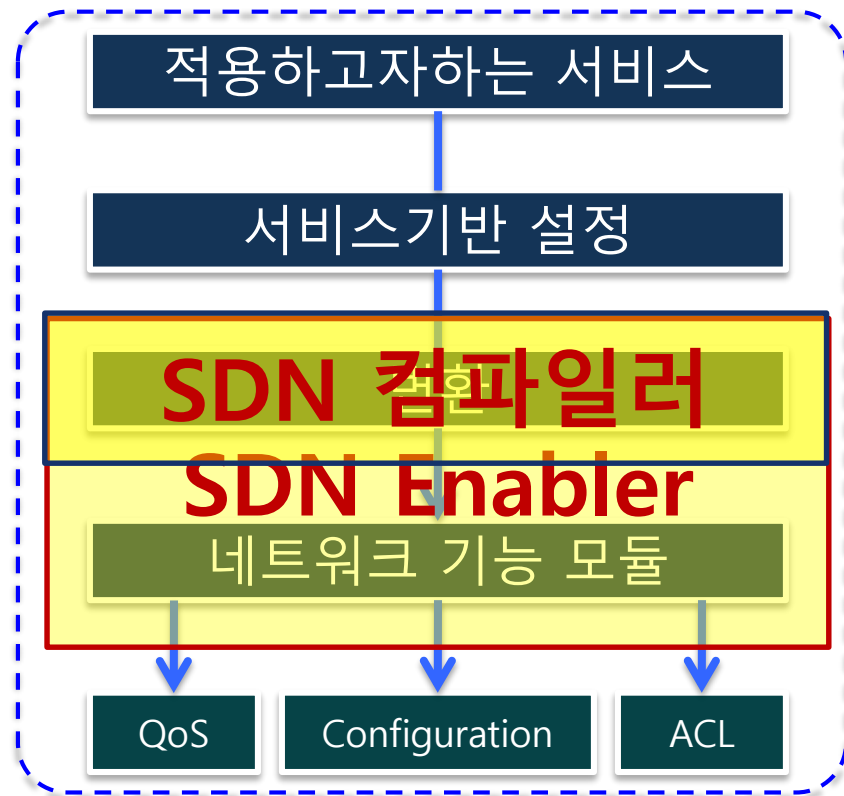
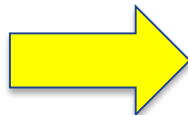

정책기반 서비스 플랫폼 예시

IP 1.1.1.1이 비정상 트래픽을 발생하고 있습니다. 차단해주세요!!



네트워크 운영자

1.1.1.1이
연결된 장비 확인
(장비2 interface 0/0)



관련 장비들을 선택하여
차단 명령어 설정
(interface 0/0 shutdown 또는
deny all 1.1.1.1)

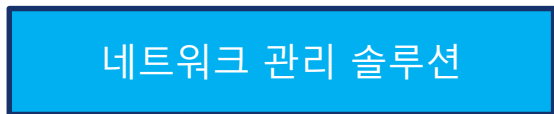

Deny ip 1.1.1.1 any Interface 0/0 shutdown Deny all

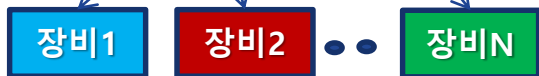

보안담당자



헬프데스크

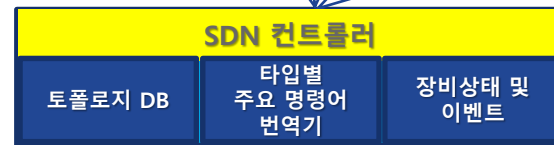
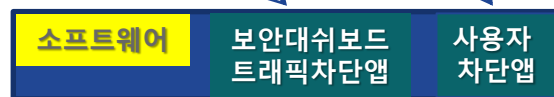

Deny ip 1.1.1.1 any Interface 0/0 shutdown Deny all

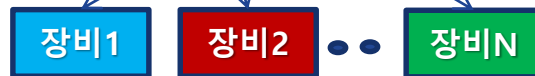

시스코 APIC-EM 아키텍처



엔터프라이즈 어플리케이션 플랫폼

어플리케이션
플랫폼
= 컨트롤러

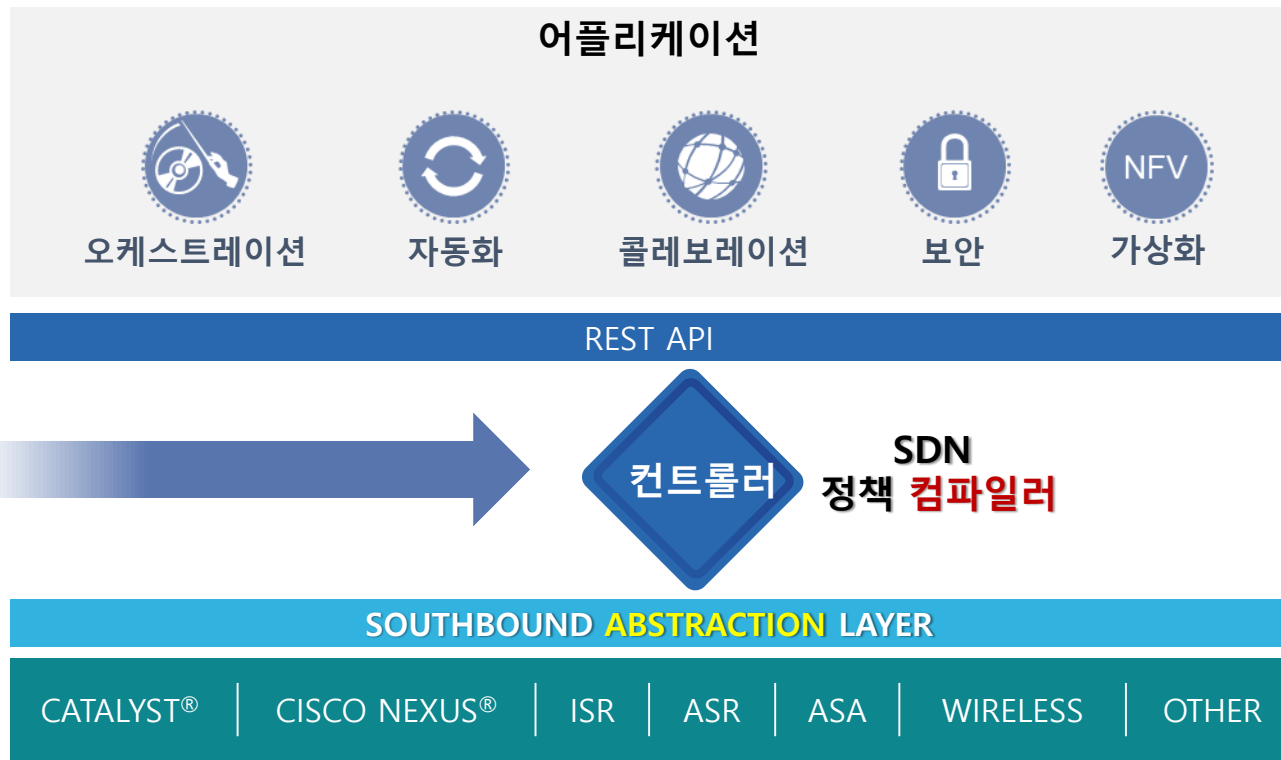

시스코 장비로 구성된 **기존 네트워크 대상**

A photograph of a server room with rows of white server racks. The room is brightly lit with overhead lights. The floor has a light-colored geometric pattern. A blue overlay covers the left side of the image, where the text is located. One server rack door is open, revealing internal components.

통신사업자 SDN 전략

통신사업자의 SDN 전략

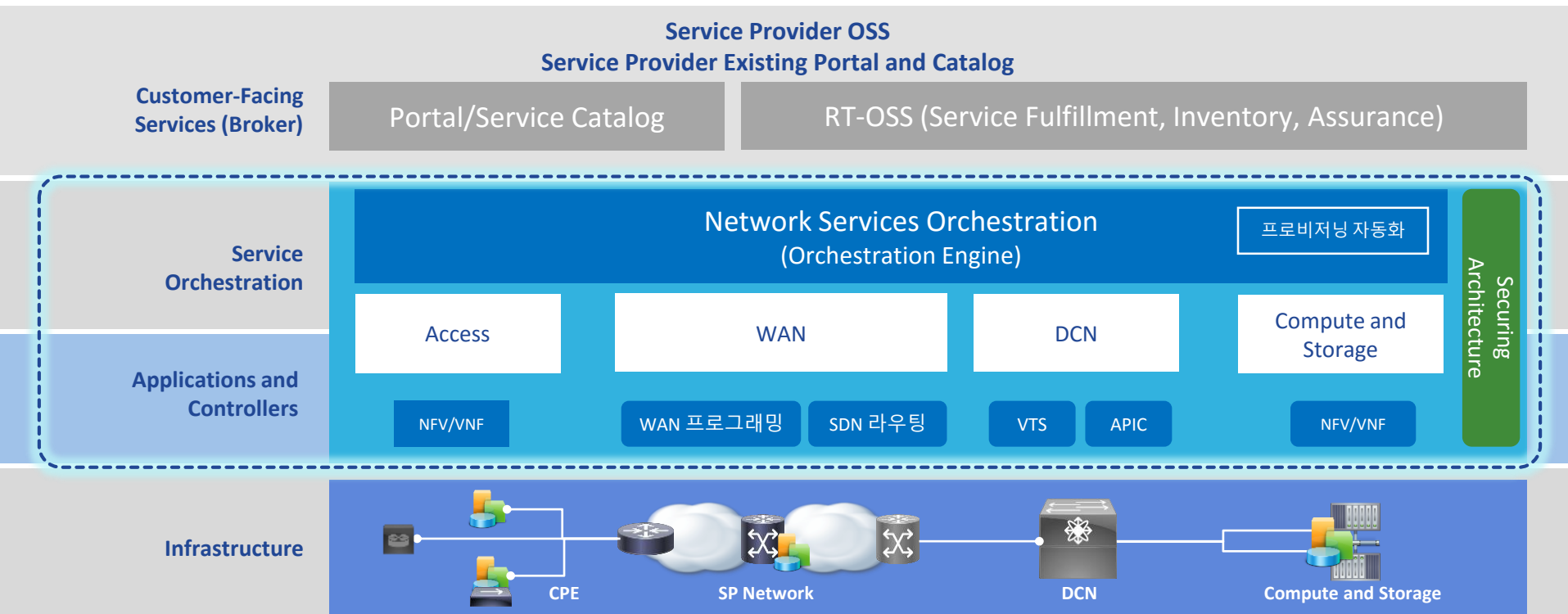

Access 네트워크의 SDN

- SDN과 Controller에서 통합 제어 기능 수행
- 노드에서는 해당 트래픽에 대한 데이터 전달 역할 수행
- 서비스별 네트워크 경로의 다이내믹한 제어 기능 제공

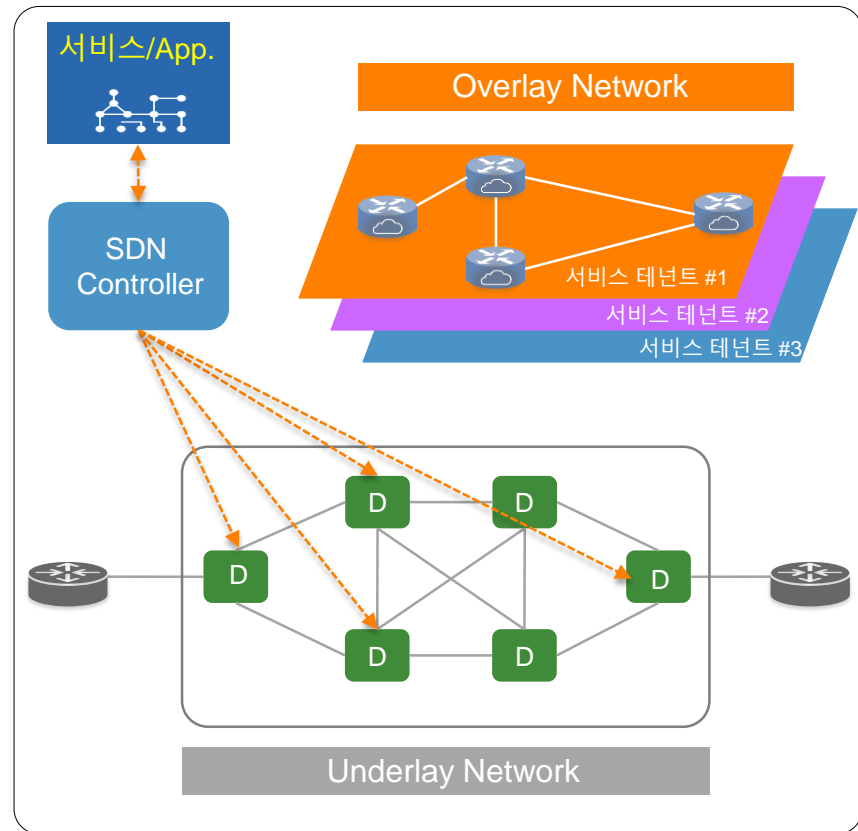
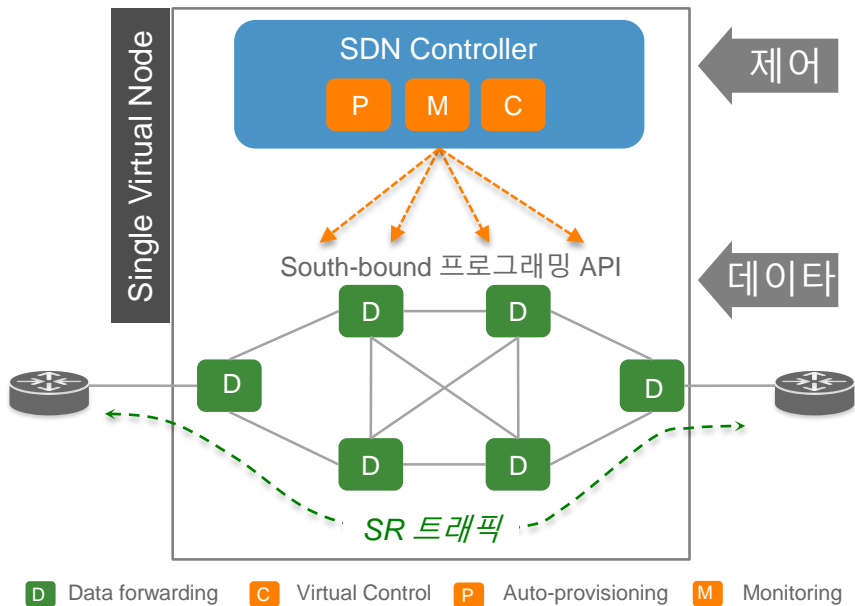

WAN 네트워크에서의 SDN

WAN 프로그래밍 Applications

네트워크 경로에 대한 프로그래밍 (PECP, BGP-LS 등)

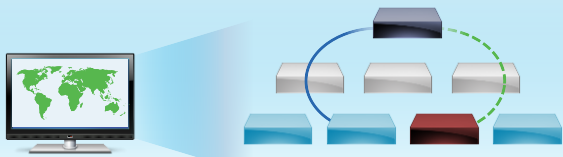

SDN 라우팅 : Segment Routing

Source routing기반의 신개념 어플리케이션 라우팅



Unified Multilayer

IP와 Optical 네트워크의 통합 SDN 솔루션

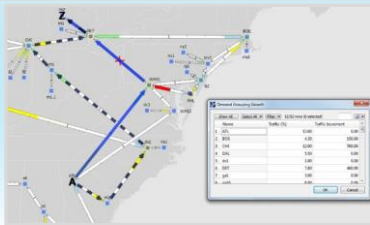

SDN 통합 솔루션

통합 SDN Controller 기반의 End-End 네트워크 제어



자동화 & 오케스트레이션

SDN기반의 네트워크 서비스 자동화 솔루션

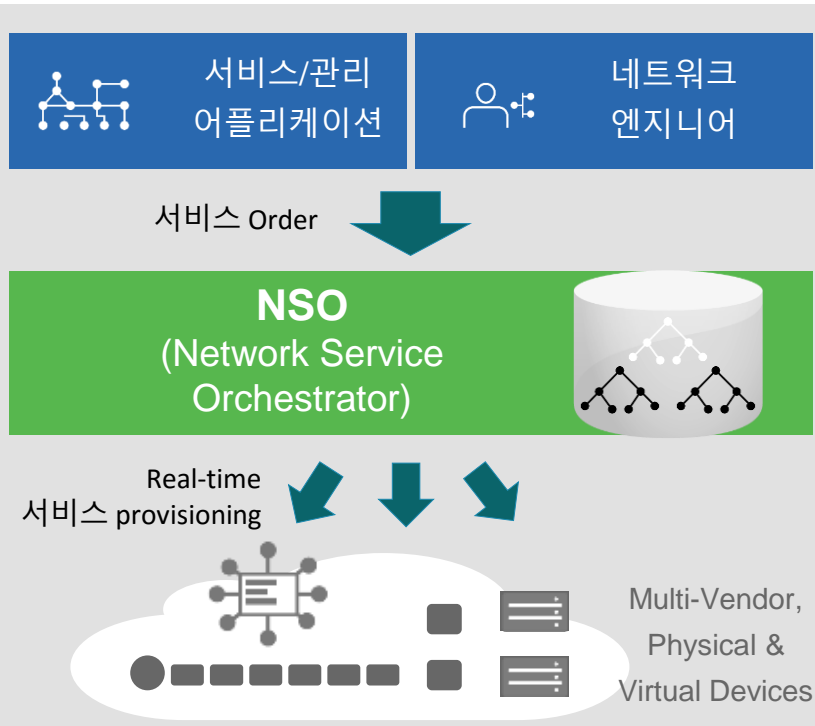

[AS-IS]

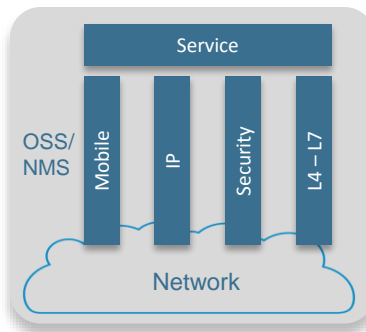

- Silo 형태로 각 도메인별 분리
- 특정 벤더 종속성
- HW 기반의 네트워크 중점

[TO-BE]

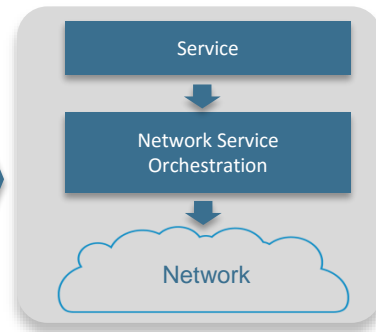

- 서비스 관점에서의 네트워크 통합
- 멀티 벤더 솔루션 지향
- HW 및 가상 네트워크(NFV) 서비스 통합

- 유연성있는 멀티벤더 지원 솔루션
- 개방형 프로토콜 (Netconf/Yang, REST, SNMP 등)
- Physical 및 NFV Virtual 네트워크 장비 지원

Summary

Innovation, Disruption, Open

Application Centric Infrastructure for 데이터센터

APIC-EM for 엔터프라이즈 네트워크

NSO for 통신사업자



CISCO

TOMORROW starts here.